

# CONCRETE PROJECT

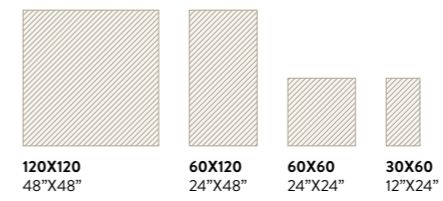

# CONCRETE PROJECT



**GRES PORCELLANATO A TUTTO SPESSORE**  
FULL BODY PORCELAIN TILES





# CONCRETE PROJECT

CONPROJ R12DG

CONPROJ R12W

CONPROJ RB60G

CONCRETE PROJECT

CONPROJ120DG

CONPROJ120G



CONCRETE PROJECT

CONPROJ120DG

CONPROJ120G



# CONCRETE PROJECT

CONPROJ 12DG

CONPROJ 12MU

CONPROJ 120W

CONPROJ 36DG

LCONPROJ 10MU



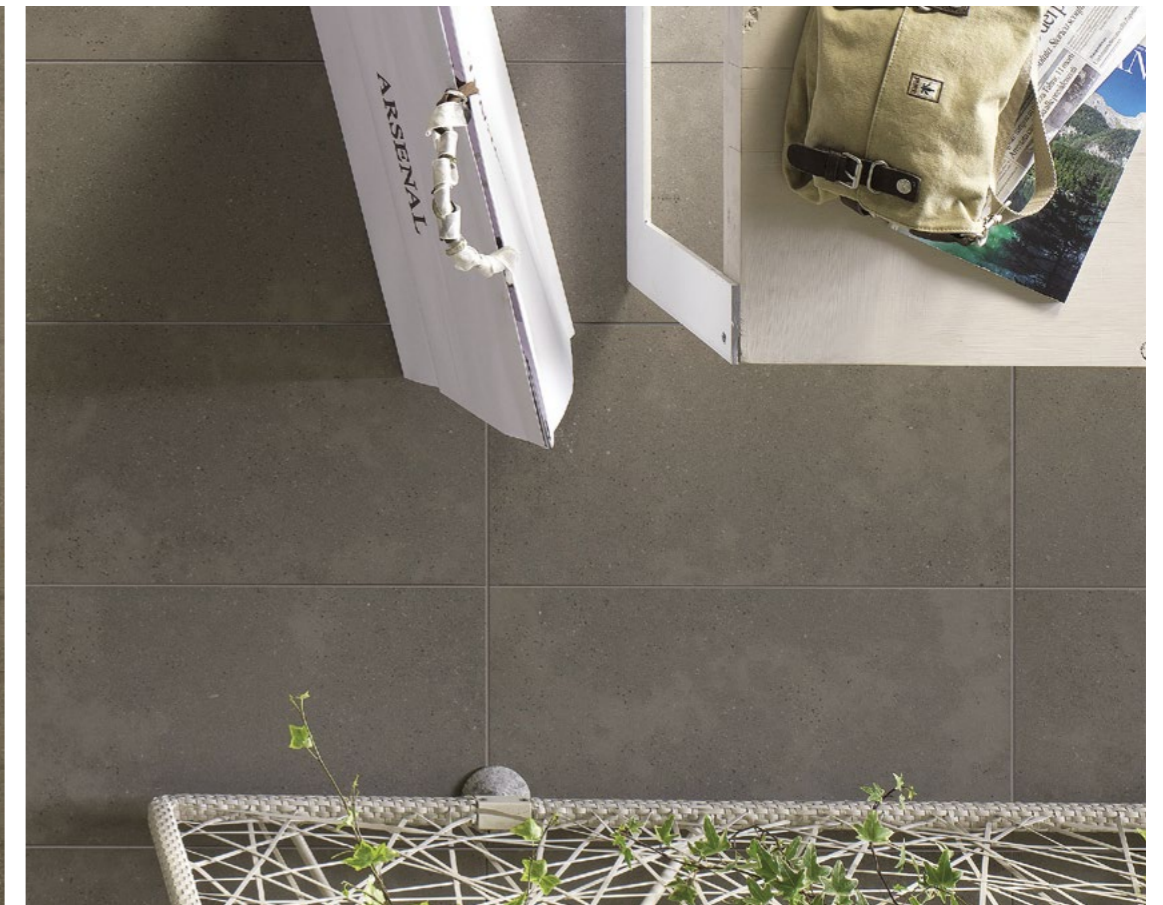

CONPROJ R12B  
CONPROJ 12A LP

CONCRETE PROJECT





CONPROJ R12B  
CONPROJ 12A LP

CONCRETE PROJECT





**CONCRETE PROJECT**

---

CONPROJ 12N

---

LCONPROJ 10N

---

LCONPROJ 20N

---

LCONPROJ 30N



**CONCRETE PROJECT**

CONPROJ 12N

LCONPROJ 10N

LCONPROJ 20N

LCONPROJ 30N

CONCRETE PROJECT

CONPROJ120R



GRES PORCELLANATO A TUTTO SPESSORE / FULL BODY PORCELAIN TILES

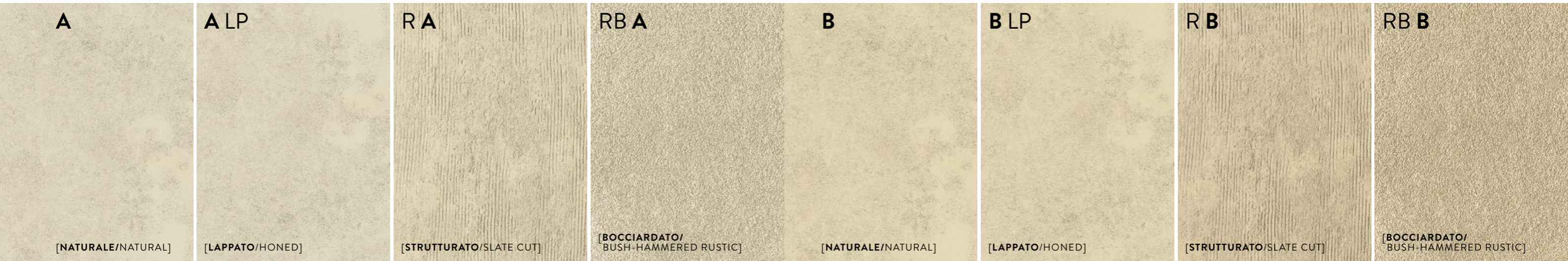
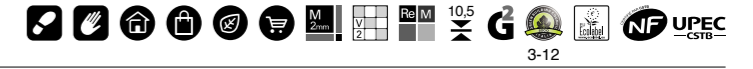

[NATURALE/NATURAL]

[LAPPATO/HONED]

[STRUTTURATO/SLATE CUT]

[BOCCIARDATO/  
BUSH-HAMMERED RUSTIC]

[NATURALE/NATURAL]

[LAPPATO/HONED]

[STRUTTURATO/SLATE CUT]

[BOCCIARDATO/  
BUSH-HAMMERED RUSTIC]

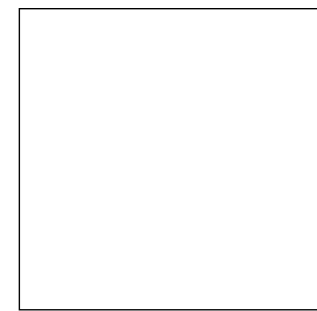

120X120-48"X48"

CONPROJ 120A  
CONPROJ 120A LP



60X120-24"X48"

CONPROJ 12A  
CONPROJ 12A LP  
CONPROJ R12A



60X60-24"X24"

CONPROJ 60A  
CONPROJ 60A LP  
CONPROJ RB60A



30X60-12"X24"

CONPROJ 36A  
CONPROJ 36A LP  
CONPROJ R36A  
CONPROJ RB36A

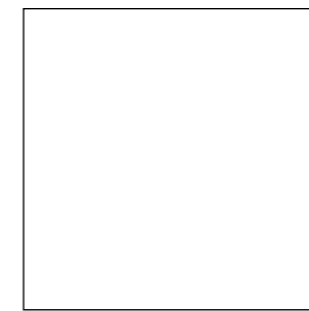

120X120-48"X48"

CONPROJ 120B  
CONPROJ 120B LP

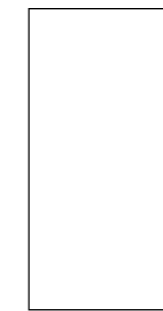

60X120-24"X48"

CONPROJ 12B  
CONPROJ 12B LP  
CONPROJ R12B

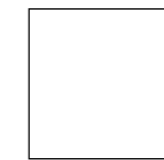

60X60-24"X24"

CONPROJ 60B  
CONPROJ 60B LP  
CONPROJ RB60B



30X60-12"X24"

CONPROJ 36B  
CONPROJ 36B LP  
CONPROJ R36B  
CONPROJ RB36B



MK.CONPROJ 30A  
30X30-12"X12"

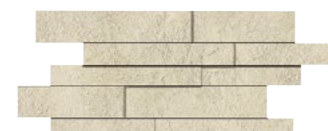

MU.CONPROJ 36A  
30X60-12"X24" ▲



MK.CONPROJ 30B  
30X30-12"X12"

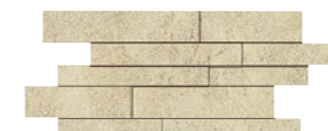

MU.CONPROJ 36B  
30X60-12"X24" ▲

GRES PORCELLANATO A TUTTO SPESSORE / FULL BODY PORCELAIN TILES

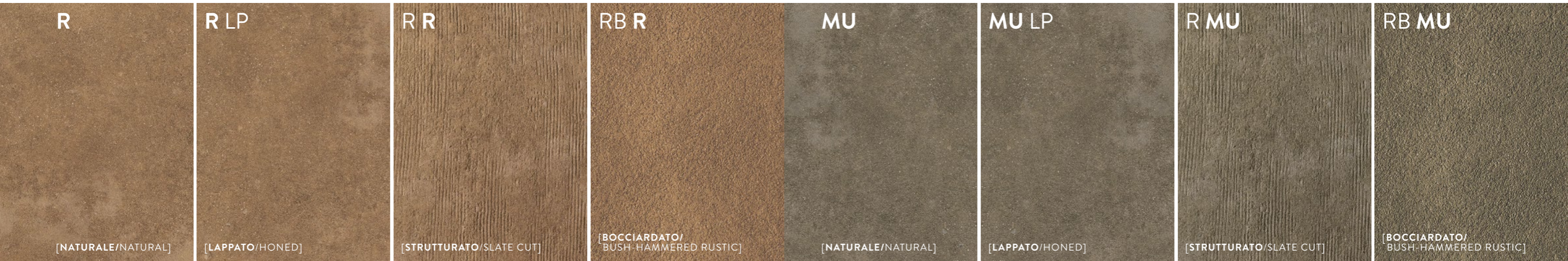
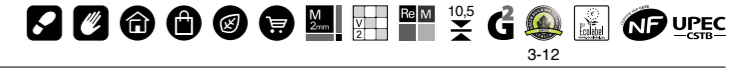

[NATURALE/NATURAL]

[LAPPATO/HONED]

[STRUTTURATO/SLATE CUT]

[BOCCIARDATO/  
BUSH-HAMMERED RUSTIC]

[NATURALE/NATURAL]

[LAPPATO/HONED]

[STRUTTURATO/SLATE CUT]

[BOCCIARDATO/  
BUSH-HAMMERED RUSTIC]



120X120-48"X48"

CONPROJ 120R  
CONPROJ 120R LP

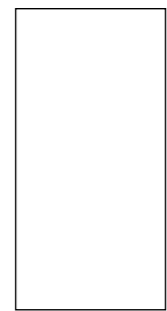

60X120-24"X48"

CONPROJ 12R  
CONPROJ 12R LP  
CONPROJ R12R



60X60-24"X24"

CONPROJ 60R  
CONPROJ 60R LP  
CONPROJ RB60R



30X60-12"X24"

CONPROJ 36R  
CONPROJ 36R LP  
CONPROJ R36R  
CONPROJ RB36R

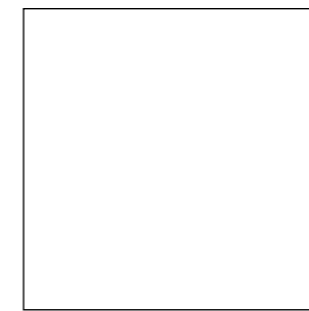

120X120-48"X48"

CONPROJ 120MU  
CONPROJ 120MULP



60X120-24"X48"

CONPROJ 12MU  
CONPROJ 12MULP  
CONPROJ R12MU

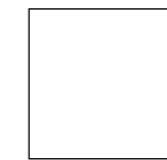

60X60-24"X24"

CONPROJ 60MU  
CONPROJ 60MULP  
CONPROJ RB60MU

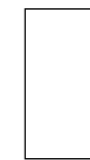

30X60-12"X24"

CONPROJ 36MU  
CONPROJ 36MULP  
CONPROJ R36MU  
CONPROJ RB36MU



30X120-12"X48"

L.CONPROJ 30MU



20X120-8"X48"

L.CONPROJ 20MU



10X120-4"X48"

L.CONPROJ 10MU



MK.CONPROJ 30R  
30X30-12"X12"

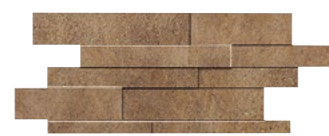

MU.CONPROJ 36R  
30X60-12"X24"

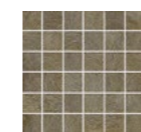

MK.CONPROJ 30MU  
30X30-12"X12"

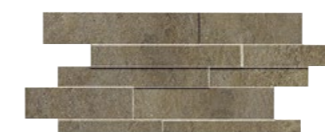

MU.CONPROJ 36MU  
30X60-12"X24"

GRES PORCELLANATO A TUTTO SPESSORE / FULL BODY PORCELAIN TILES

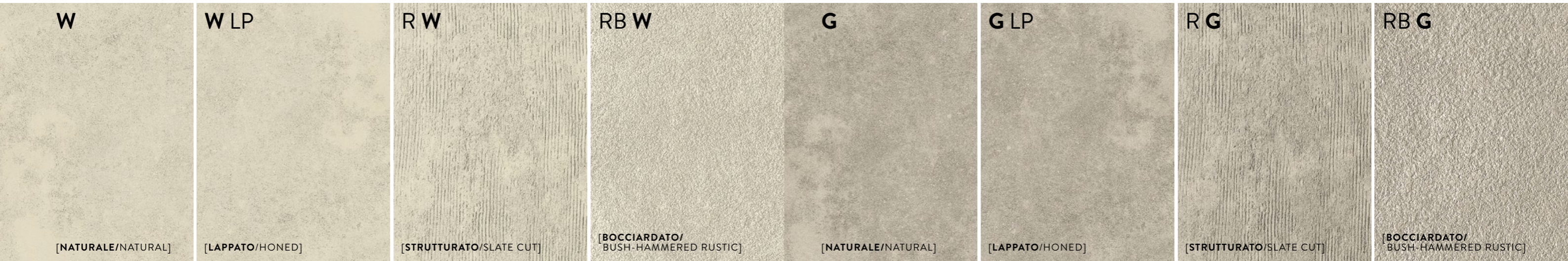
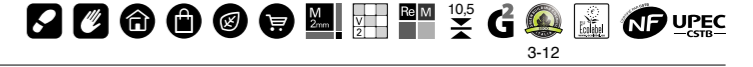

N LI

LP LI

N ST

N RB

N LI

LP LI

N ST

N RB

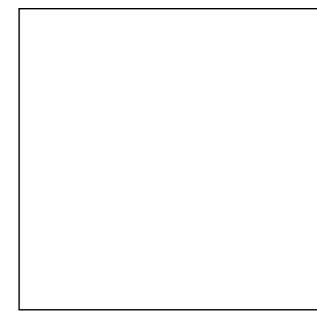

120X120-48"X48"

CONPROJ 120W  
CONPROJ 120W LP

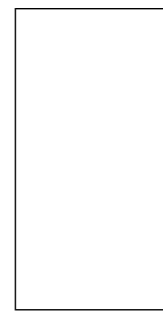

60X120-24"X48"

CONPROJ 12W  
CONPROJ 12W LP  
CONPROJ R12W

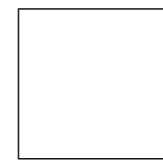

60X60-24"X24"

CONPROJ 60W  
CONPROJ 60W LP  
CONPROJ RB60W



30X60-12"X24"

CONPROJ 36W  
CONPROJ 36W LP  
CONPROJ R36W  
CONPROJ RB36W

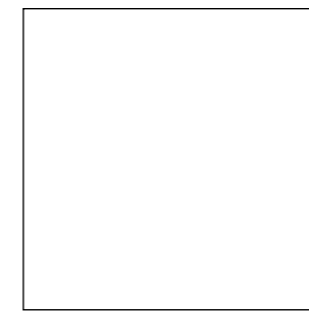

120X120-48"X48"

CONPROJ 120G  
CONPROJ 120G LP



60X120-24"X48"

CONPROJ 12G  
CONPROJ 12G LP  
CONPROJ R12G



60X60-24"X24"

CONPROJ 60G  
CONPROJ 60G LP  
CONPROJ RB60G



30X60-12"X24"

CONPROJ 36G  
CONPROJ 36G LP  
CONPROJ R36G  
CONPROJ RB36G



30X120-12"X48"

L.CONPROJ 30G



20X120-8"X48"

L.CONPROJ 20G



10X120-4"X48"

L.CONPROJ 10G

N LI



MK.CONPROJ 30W  
30X30-12"X12"



MU.CONPROJ 36W  
30X60-12"X24"



N LI



MK.CONPROJ 30G  
30X30-12"X12"

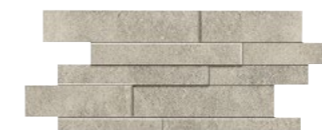

MU.CONPROJ 36G  
30X60-12"X24"



GRES PORCELLANATO A TUTTO SPESSORE / FULL BODY PORCELAIN TILES

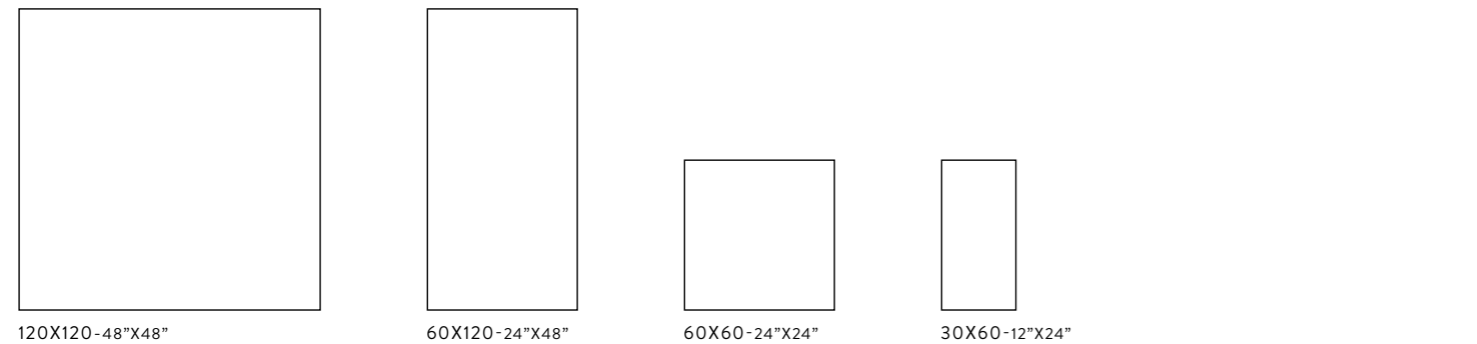
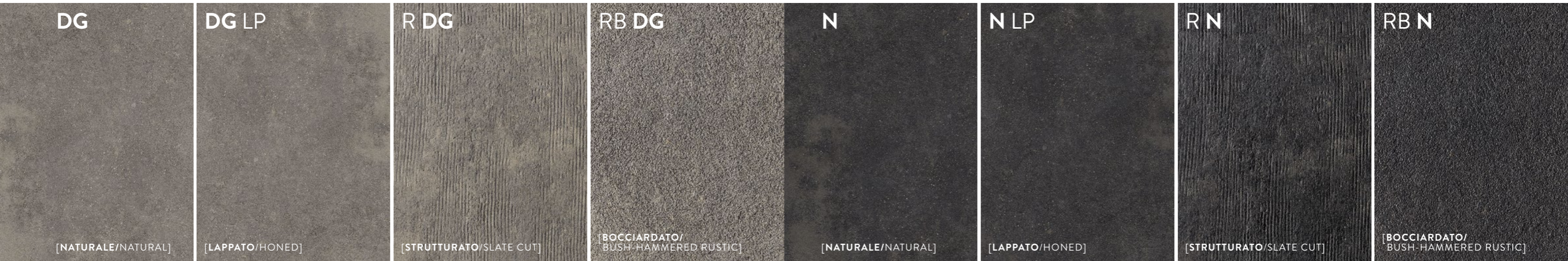
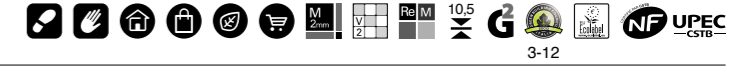

**CONPROJ 120DG**  
**CONPROJ 120DGLP**  
**CONPROJ 12DG**  
**CONPROJ 12DGLP**  
**CONPROJ R12DG**  
**CONPROJ 60DG**  
**CONPROJ 60DGLP**  
**CONPROJ RB60DG**  
**CONPROJ 36DG**  
**CONPROJ 36DGLP**  
**CONPROJ R36DG**  
**CONPROJ RB36DG**

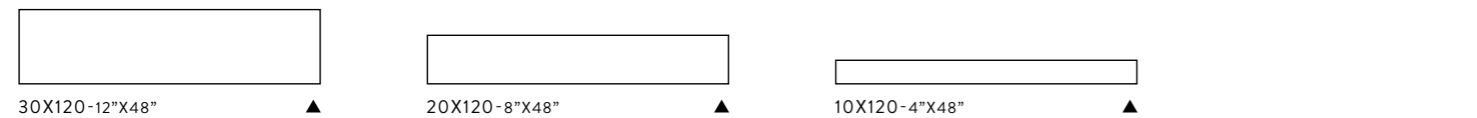

**L.CONPROJ 30DG**  
**L.CONPROJ 20DG**  
**L.CONPROJ 10DG**

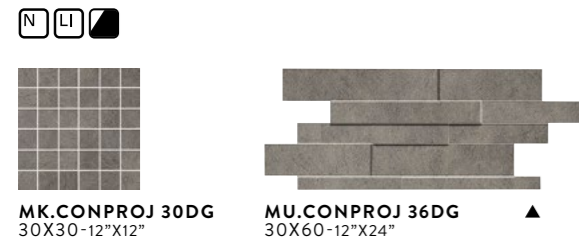

**MK.CONPROJ 30DG**  
**30X30-12"x12"**  
**MU.CONPROJ 36DG**  
**30X60-12"x24"**

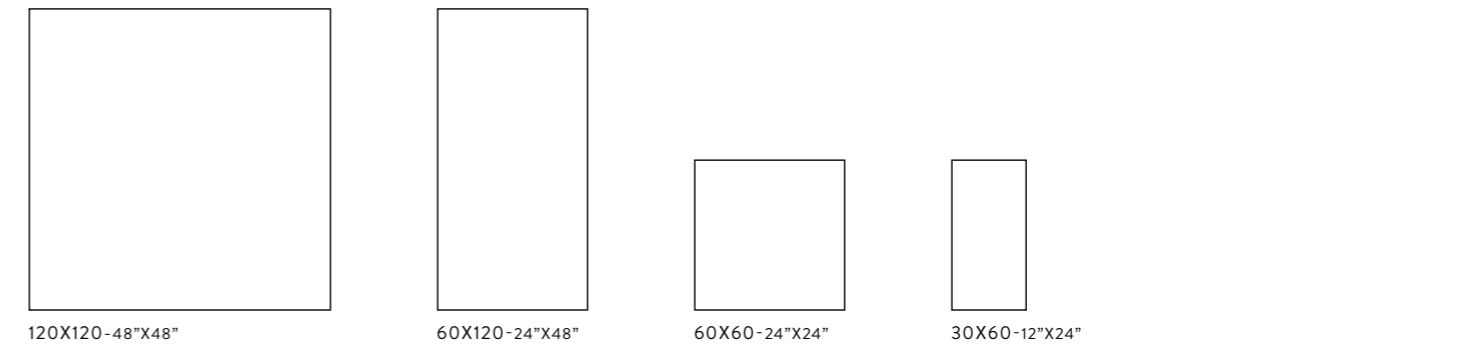

**CONPROJ 120N**  
**CONPROJ 120N LP**  
**CONPROJ 12N**  
**CONPROJ 12N LP**  
**CONPROJ R12N**  
**CONPROJ 60N**  
**CONPROJ 60N LP**  
**CONPROJ RB60N**  
**CONPROJ 36N**  
**CONPROJ 36N LP**  
**CONPROJ R36N**  
**CONPROJ RB36N**

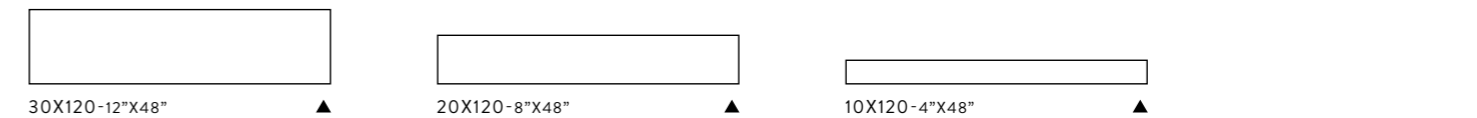



**L.CONPROJ 30N**  
**L.CONPROJ 20N**  
**L.CONPROJ 10N**



**L.CONPROJ3D 30N**  
**MK.CONPROJ 30N**  
**30X30-12"x12"**  
**MU.CONPROJ 36N**  
**30X60-12"x24"**

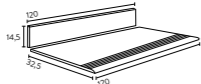

## PEZZI SPECIALI / SPECIAL PIECES

	 9,5X60-3.7"X24" ▲	 60X120-24"X48" ▲	 120X32,5-48"X12.8" ▲	 120X32,5-48"X12.8" ▲
[A]	CONPROJ BT 60A	CONPROJ KIT 12A	CONPROJ G120A	CONPROJ A120ADX CONPROJ A120ASX
[B]	CONPROJ BT 60B	CONPROJ KIT 12B	CONPROJ G120B	CONPROJ A120BDX CONPROJ A120BSX
[R]	CONPROJ BT 60R	CONPROJ KIT 12R	CONPROJ G120R	CONPROJ A120RDX CONPROJ A120RSX
[MU]	CONPROJ BT 60MU	CONPROJ KIT 12MU	CONPROJ G120MU	CONPROJA120MUDX CONPROJA120MUSX
[W]	CONPROJ BT 60W	CONPROJ KIT 12W	CONPROJ G120W	CONPROJ A120WDX CONPROJ A120WSX
[G]	CONPROJ BT 60G	CONPROJ KIT 12G	CONPROJ G120G	CONPROJ A120GDX CONPROJ A120GSX
[DG]	CONPROJ BT 60DG	CONPROJ KIT 12DG	CONPROJ G120DG	CONPROJA120DGDX CONPROJA120DGSX
[N]	CONPROJ BT 60N	CONPROJ KIT 12N	CONPROJ G120N	CONPROJ A120NDX CONPROJ A120NSX

## CARATTERISTICHE TECNICHE SPECIFICHE / TECHNICAL FEATURES SPECIFICATIONS

	DIN 51130 (R)	DIN 51097 (A+B+C)	BOT 3000 (DCOF)	BCR REP. CEC 6/81		DM 14/6/89 N. 236	
				G.A.	G.B.	C.A.	G.B.
CONPROJ	R10	A	>0,42	>0,4	>0,4	>0,4	>0,4
CONPROJ RB	R11	A+B	>0,42	>0,4	>0,4	>0,4	>0,4
CONPROJ R	R11	A+B	>0,42	>0,4	>0,4	>0,4	>0,4



CONPROJ 12A LP

## SIMBOLOGIA SYMBOLS

### INDICAZIONI D'USO. INDICATIONS FOR USE.



**PAVIMENTO.**  
FLOOR TILES.



**RIVESTIMENTO.**  
WALL TILES.

### FINITURA. FINISH.



**NATURALE.**  
NATURAL.



**LAPPATO.**  
HONED.

### BORDO. EDGE.



**RETTIFICATO MONOCALIBRO.**  
MONOCALIBER, RECTIFIED.

### STRUTTURA. STRUCTURE.



**LISCIO.**  
SMOOTH.



**STUTTURATO.**  
SLATE CUT.



**BOCCIARDATO.**  
BUSH-HAMMERED RUSTIC.

### DESTINAZIONI D'USO. SUGGESTED APPLICATIONS.



**ABITAZIONI.**  
DOMESTIC PURPOSE.



**COMMERCIALE LEGGERO.**  
TILES FOR LIGHT COMMERCIAL TRAFFIC AREA.



**COMMERCIALE PESANTE.**  
TILES FOR HEAVY TRAFFIC AREA.



**ESTERNI.**  
OUTDOOR FLOOR.

### MODULARE. MODULAR.



**MODULARE 2 mm**  
MODULAR 2 MM

### ASPETTO SUPERFICIALE. SURFACE LOOK.



**OPACO.**  
MATT.



**SEMILUCIDO.**  
SEMI-GLOSSY.

### CARATTERISTICHE DI VENDITA. SALES CHARACTERISTICS.

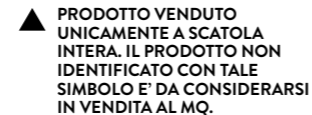

**PRODOTTO VENDUTO UNICAMENTE A SCATOLA INTERA. IL PRODOTTO NON IDENTIFICATO CON TALE SIMBOLO E' DA CONSIDERARSI IN VENDITA AL MQ.**

PRODUCT SOLD ONLY IN COMPLETE BOXES. IF THE PRODUCT IS NOT MARKED WITH THIS SYMBOL IT SHOULD BE CONSIDERED AS SOLD BY M<sup>2</sup>.

### STONALIZZAZIONE. SHADE VARIATION.



**V2**

## CERTIFICAZIONI CERTIFICATIONS

LA NATURA E LA TECNOLOGIA SI FONDONO PER DAR VITA A UN NUOVO CONCETTO DI CERAMICA CHE METTE AL CENTRO IL RAPPORTO TRA L'UOMO E L'AMBIENTE; UN BINOMIO INSCINDIBILE PER IL CONSEGUIMENTO CONSAPEVOLE DEI PRINCIPI DI ECO-EFFICIENZA AZIENDALE ED ECO-COMPATIBILITÀ AMBIENTALE SIGILLATO DA IMPORTANTI RICONOSCIMENTI.

NATURE AND TECHNOLOGY COMBINE TO GIVE BIRTH TO A NEW CONCEPT IN CERAMIC TILES WHICH PLACES THE RELATIONSHIP BETWEEN MAN AND THE ENVIRONMENT AT THE CENTRE; AN INSEPARABLE COMBINATION FOR THE CONSCIOUS ACHIEVEMENT OF ECO-EFFICIENT CORPORATE PRINCIPLES AS WELL AS THOSE OF ENVIRONMENTAL ECO-COMPATIBILITY, SEALED WITH IMPORTANT RECOGNITIONS.

### ISO 14001

IL SISTEMA DI GESTIONE AMBIENTALE DI COOPERATIVA CERAMICA D'IMOLA - IN RIFERIMENTO ALLA NORMA UNI EN ISO 14001 - È STATO IMPOSTATO PERSEGUENDO I SEGUENTI PRINCIPI:

- SALVAGUARDIA DELL'AMBIENTE E DELLE RISORSE NATURALI.
- POLITICA ENERGETICA EFFICACE ED EFFICIENTE.
- RISPETTO PER L'ECOSISTEMA.

THE ENVIRONMENTAL MANAGEMENT SYSTEM OF COOPERATIVA CERAMICA D'IMOLA - IN REFERENCE TO THE UNI EN ISO 14001 NORMATIVE - WAS IMPOSED ON THE BASIS OF THE FOLLOWING PRINCIPLES:

- PROTECTION OF THE ENVIRONMENT AND OF NATURAL RESOURCES.
- EFFICIENT AND EFFECTIVE ENERGY POLICY.
- RESPECT FOR THE ECOSYSTEM.



### ISO 9001

COOPERATIVA CERAMICA D'IMOLA HA OTTENUTO LA CERTIFICAZIONE DEL SISTEMA DI QUALITÀ IN RIFERIMENTO ALLA NORMA UNI EN ISO 9001, PER LA PROGETTAZIONE, PRODUZIONE E VENDITA DI PIASTRELLE CERAMICHE IN TUTTE LE TIPOLOGIE PRODUTTIVE.

L'IMPLEMENTAZIONE DI TALE SISTEMA HA I SEGUENTI OBIETTIVI:

- PERSEGUIRE, ATTRAVERSO UN'ADEGUATA GESTIONE DELLE RISORSE TECNICHE E IMPIANTISTICHE, IL CONTINUO MIGLIORAMENTO DEI PROCESSI PRODUTTIVI;
- GARANTIRE IL CORRETTO IMPIEGO, L'EFFICIENZA, L'ATTENDIBILITÀ ED AFFIDABILITÀ DEI RISULTATI DI MISURE E PROVE, ATTRAVERSO LA PIANIFICAZIONE DELLA MANUTENZIONE ED IL CONTROLLO DI IMPIANTI, APPARECCHIATURE E STRUMENTAZIONI;
- CONTRIBUIRE AL MIGLIORAMENTO DEL CONTESTO SOCIALE DI CUI È PARTE, NEL RISPETTO DELLE PERSONE E DELL'AMBIENTE IN CUI È INTEGRATA.

COOPERATIVA CERAMICA D'IMOLA HAS OBTAINED THE QUALITY SYSTEM CERTIFICATION, IN RELATION TO THE UNI EN ISO 9001 NORMATIVE, FOR THE DESIGN, PRODUCTION AND MARKETING OF CERAMIC TILES FOR ALL OF THE PRODUCTION TYPES.

IMPLEMENTATION OF THIS SYSTEM - IN RELATION TO THE UNI EN ISO 9001 NORMATIVE - HAS THE FOLLOWING OBJECTIVES:

- ACHIEVEMENT, THROUGH ADEQUATE MANAGEMENT OF THE TECHNICAL AND SYSTEM RESOURCES, OF THE ONGOING IMPROVEMENT OF THE PRODUCTION PROCESSES.
- GUARANTEE THE CORRECT USE, EFFICIENCY, RELIABILITY AND DEPENDABILITY OF THE RESULTS OF THE MEASUREMENTS AND TESTS THROUGH THE PLANNING OF THE MAINTENANCE AND THE CONTROL OF THE SYSTEMS, EQUIPMENT AND INSTRUMENTATION.
- CONTRIBUTE TO THE IMPROVEMENT OF THE SOCIAL CONTEXT OF WHICH IT IS PART AND IN TERMS OF THE PEOPLE AND THE ENVIRONMENT INTO WHICH IT IS INTEGRATED.



### EMAS

COOPERATIVA CERAMICA D'IMOLA, ATTUANDO UNA PRECISA POLITICA AZIENDALE DI SVILUPPO SOSTENIBILE, HA OTTENUTO LA REGISTRAZIONE ECO-MANAGEMENT AND AUDIT SCHEME (EMAS), UN IMPORTANTE RICONOSCIMENTO A LIVELLO EUROPEO, RELATIVO AI SITI PRODUTTIVI, VOLTO AL CONTINUO MIGLIORAMENTO DEGLI STANDARD PRODUTTIVI E ALLA SENSIBILIZZAZIONE DI TUTTO IL PERSONALE SOTTO IL PROFILO DELLA SALVAGUARDIA AMBIENTALE.

THROUGH THE IMPLEMENTATION OF A PRECISE COMPANY POLICY ON SUSTAINABLE DEVELOPMENT, COOPERATIVA CERAMICA D'IMOLA HAS OBTAINED ECO-MANAGEMENT AND AUDIT SCHEME (EMAS) REGISTRATION. THIS IS AN IMPORTANT RECOGNITION ON A EUROPEAN LEVEL THAT AIM AT THE CONTINUOUS IMPROVEMENT OF PRODUCTION STANDARDS AND AWARENESS OF ALL OF ITS EMPLOYEES IN TERMS OF PROTECTING THE ENVIRONMENT. THE EMAS SYSTEM IS A VOLUNTARY AWARENESS FOR THOSE COMPANIES COMMITTED TO EVALUATING AND IMPROVING THEIR ENVIRONMENTAL EFFICIENCY THROUGH A MORE RESPONSIBLE CHOICE OF BUYING AND MANAGEMENT, A MORE CAREFUL USE OF AIR, WATER, TERRITORY, RAW MATERIALS AND ENERGY.



### LEED

COOPERATIVA CERAMICA D'IMOLA È MEMBRO DEL GREEN BUILDING COUNCIL ITALIA, CHE OPERA PER LA DIFFUSIONE DEI CRITERI DEL MARCHIO LEED. LE PIASTRELLE, IN RELAZIONE ALLE CARATTERISTICHE E AL PROCESSO PRODUTTIVO CON CUI SONO REALIZZATE, POSSONO CONTRIBUIRE AD OTTENERE CREDITI L.E.E.D (LEADERSHIP IN ENERGY AND ENVIRONMENTAL DESIGN). IL LEED È UN SISTEMA DI CERTIFICAZIONE ENERGETICO - AMBIENTALE DEGLI EDIFICI CHE PREVEDE L'ATTRIBUZIONE DI UN PUNTEGGIO, ASSEGNATO IN FUNZIONE DELLA COMPROVATA CONFORMITÀ RISPETTO AD ALCUNI "CREDITI" PRESTABILITI. TALE CONTRIBUTO VA VALUTATO NEL TOTALE DEI MATERIALI UTILIZZATI NELL'EDIFICIO.

COOPERATIVA CERAMICA D'IMOLA IS A MEMBER OF THE GREEN BUILDING COUNCIL ITALIA, WHICH OPERATES FOR THE DIFFUSION OF THE LEED ACCREDITATION SYSTEM. IN RELATION TO THE CHARACTERISTICS AND PRODUCTION PROCESS IN WHICH THEY ARE MANUFACTURED, TILES CAN CONTRIBUTE TO OBTAINING L.E.E.D (LEADERSHIP IN ENERGY AND ENVIRONMENTAL DESIGN) CREDITS. LEED IS AN ENERGY-ENVIRONMENTAL ACCREDITATION SYSTEM FOR BUILDINGS AND IS CHARACTERISED BY A POINTS SYSTEM ATTRIBUTED ACCORDING TO THE VERIFIED CONFORMITY OF SEVERAL PRE-ESTABLISHED "CREDITS". THIS CONTRIBUTION IS EVALUATED OVER THE TOTAL OF MATERIALS USED IN THE BUILDING.





IMOLACERAMICA.IT



CONCRETE PROJECT

---

A brand of  
**Cooperativa Ceramica d'Imola S.c.**

Via V. Veneto, 13  
40026 Imola (BO) Italia  
Tel. +39 0542 601601  
Fax +39 0542 31749

---